

Metal halide lamp with quartz burner

HRI-TS 2000W/D/S/400/K12S

Radium

Product Datasheet Date: 23.06.2026

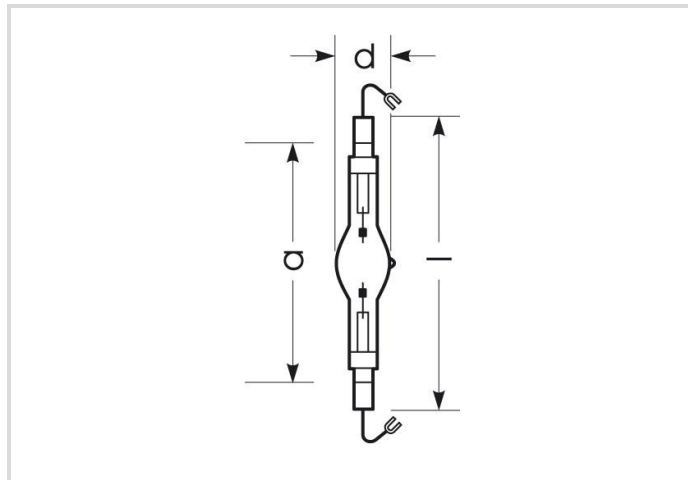

A+



210000



6100K



4 500h

General Data

Code Radium	32418615
Désignation	HRI-TS 2000W/D/S/400/K12S
EAN 10 (unité)	4008597186158
Unité de transport (pièces)	10
EAN 40 (carton)	4008597486159
Poids brut du carton en kg	1.446
Longueur box in m	0.39
Largeur du carton en m	0.158
Hauteur du carton en m	0.258
Product weight	61 g
Product status	● Actif

Electric Parameters

Wattage	1950.0 W
Lamp nominal wattage	2000 W
Lamp voltage	220-230 V
Lamp voltage	190 V
Mains voltage	400 V

Electric Parameters

Ignition voltage	4.0 up to 5.0
Hot restrike voltage	36 kV
Lamp's nominal current	11.3 A
Nominal choke current	10.3 A
Compensation capacitor for 50Hz operation	60 µF
Running up current max.	190%
Fuse	Daelay-action; min. double nominal current
dimnable	Non
Controllable (in suitable circuit)	Non

Light Application Parameters

Luminous flux	210000 lm
Rated lamp luminous flux	210000 lm
Efficacy	108 lm/W
Total mains efficacy	100 lm/W
Light colour	daylight
Colour temperature	6100 K
Color rendering index	83
Rated colour rendering index Ra	83
Lumen maintenance at 2000h	0.95
Lumen maintenance at 4000h	0.90

Service Life

Average life	4500 h
B5 - Service life 5% failures	1800 h
Lamp survival factor at 2000h	0.94
Lamp survival factor at 4000h	0.76
Lamp survival factor at 6000h	0.47

Specification

Energylabel notice	no Label needed (> 82.000 lm)
Energylabel (E -> A++)	A+
Diameter	36 mm
Length	187 mm
Total length max.	187 mm
Dimension b max.	41 mm

Metal halide lamp with quartz burner

HRI-TS 2000W/D/S/400/K12S

Radium

Specification

Burning position	p15
Mercury content	180.0 mg
Lamp shape	Tube, double-ended
Model	Clear
Base	K12s-36
Colour	White

Notes on Operation

Burning position	p15
------------------	-----

Information especially for EPREL

Energylabel notice	no Label needed (> 82.000 lm)
Lighting technology	MH

Miscellaneous

Similar products	32416491
------------------	----------

Notes

Metal halide short arc lamp clear, daylight, high luminous flux, base K12s. Operation in enclosed luminaire, with ballast and (hot restrike)ignitor.

Please, refer to www.radium.de/recycling for notes on disposal of burned-out lamps as well as lamp breakage.

The field 'info about service life' contains the frame conditions according to standards based on which the specific service life has been determined. So, for example, "12B50, 50Hz" means that the mean service life (B50) has been determined with a 12h switching cycle at mains (frequency 50Hz), "3B50, HF" is based on a 3h switching cycle at electronic control gear (high frequency).

Culot

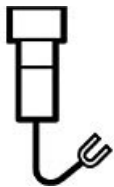

K12s-36
IEC/EN 60061-1
Sheet 7004-168-1

Courbes spectrales

Natural daylight is a mixture of direct sunlight and the light of the sky. Therefore, its spectral composition changes permanently due to the changing time of day. The standardised light classification D65 corresponds to a daylight with a colour temperature of approximately 6500 K.

Every discharge lamp type has got an individual spectral power distribution according to its chemical filling. From this result important properties light colour or colour rendering.

Should the spectral lines be very close together the lamp presumably has got a very good colour rendering index, so, Ra might be near 100. Does the spectrum rather look like single lines or frayed out the colour rendering of the lamp will probably be not as good.

If number and height of the spectral lines within the blue range (around 400 nm) prevails it might be a lamp with a rather cold light colour like for example daylight. On the other hand, should the red (around 700 nm) or the red and yellow (around 600 nm) range be dominant one can assume that the lamp will be a rather warm light colour like WDL.

After the lamp start a metal halide lamp needs about 2-4 minutes time to reach its full luminous flux, all colours in the spectrum are within the discharge arc then.

Metal halide lamp with quartz burner

HRI-TS 2000W/D/S/400/K12S

Radium

Visible region from 380 to 780 nm; height of graph corresponding with relative spectral emission (400mW/klm) per 10nm.

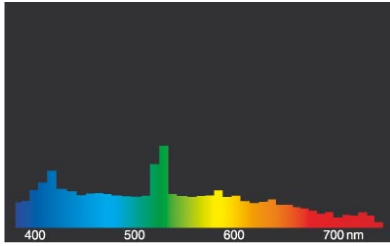

HRI.../D

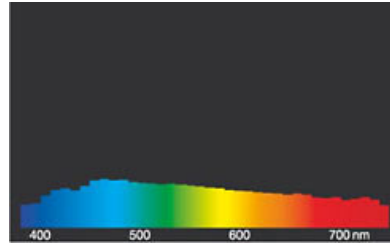

daylight(D 65)

Exemple(s) de circuit

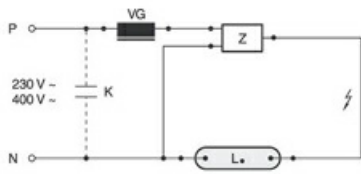

Standard circuit HID with external ignitor

Key:

L. = lamp

VG = electromagnetic ballast (KVG/VVG)

P = phase

N = zero potential

K = p. f. correction capacitor

Z = ignitor

The required control gear (here ignitor and ballast) for the lamps operation is usually mounted in the suitable luminaire in an appropriate electric circuit. Changes of any kind are to be conducted by qualified and specialised staff, only. Thus, this circuit example is to be understood merely as a technical background information for interested users.

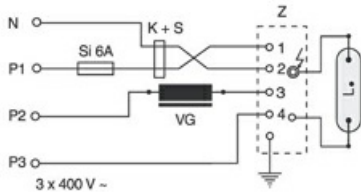

Circuit for 400V-HID-lamps suitable for hot restrike

Key:

L. = lamp

VG = electromagnetic ballast (KVG/VVG)

P = phase

N = zero potential

K = p. f. correction capacitor

Z = ignitor

S = fuse

The required control gear (here fuse, capacitor, ignitor and ballast) for the lamps operation is usually mounted in the suitable luminaire in an appropriate electric circuit. Changes of any kind are to be conducted by qualified and specialised staff, only. Thus, this circuit example is to be understood merely as a technical background information for interested users.

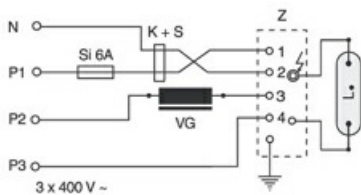

Circuit for 400V-HID-lamps suitable for hot restrike

Key:

L. = lamp

VG = electromagnetic ballast (KVG/VVG)

P = phase

N = zero potential

K = p. f. correction capacitor

Z = ignitor

S = fuse

The required control gear (here fuse, capacitor, ignitor and ballast) for the lamps operation is usually mounted in the suitable luminaire in an appropriate electric circuit. Changes of any kind are to be conducted by qualified and specialised staff, only. Thus, this circuit example is to be understood merely as a technical background information for interested users.

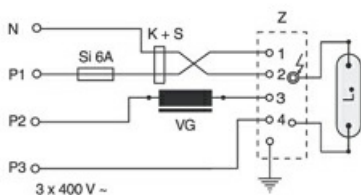

Circuit for 400V-HID-lamps suitable for hot restrike

Key:

L. = lamp

VG = electromagnetic ballast (KVG/VVG)

P = phase

N = zero potential

K = p. f. correction capacitor

Z = ignitor

S = fuse

Metal halide lamp with quartz burner

HRI-TS 2000W/D/S/400/K12S

Radium

The required control gear (here fuse, capacitor, ignitor and ballast) for the lamps operation is usually mounted in the suitable luminaire in an appropriate electric circuit. Changes of any kind are to be conducted by qualified and specialised staff, only. Thus, this circuit example is to be understood merely as a technical background information for interested users.

Particularités



Notices explicatives générales

The technical design data in accordance with DIN and IEC. The producer does not take any responsibility for damage to persons or property in case of unsuitable operation or handling of the product. Operating data and dimensions are valid within the usual tolerances. Related lamp types (different bases, mains voltages) may be available on request. Sale and delivery are effected in accordance with the Radium Terms of Delivery and Payment valid on the day of conclusion of contract. Packing units offer economical advantages to the purchase and logistic department. Please match your quantity volume accordingly. For orders of a minimum quantity (clefs) with a lamp model the amount lower than the volume of each packaging unit, we will invoice 10 % additional charge per lamp type. Technical changes and terms of delivery are reserved. Manipulation of any kind to packaging or product is not permissible as this will violate Radium brand rights. Furthermore, technical properties of the product can change to its disadvantage or even destruction. Therefore, Radium cannot be responsible for consequential damages.

® = Registered trademark

Subject to change without notice. Errors and omissions excepted.

All technical data without guarantee.